

User Manual

ANALOG TERMINAL ADAPTOR

Model: HT-882



Contents

1	Introduction	3
1.1	Overview	3
1.2	Protocols	3
1.3	Hardware Specification	4
1.4	Software Specification	4
1.5	List of the Package	4
2	Installation	5
2.1	Appearance.....	5
2.2	Connection Diagram	7
3	Basic Operations	8
3.1	Star Commands	8
3.1.1	Star Commands for Phone Configuration	8
3.1.2	Star Commands for Phone Operation	9
3.2	Set up	9
3.3	Phone Operation.....	9
3.3.1	Make a Call.....	10
3.3.2	Answer a Call	10
3.3.3	Answer a Call Waiting Call (not available in this model)	10
3.3.4	Hold a Call (For SIP only).....	10
3.3.5	Transfer a Call (For SIP only)	10
3.3.6	Call Forward (For SIP only).....	11
3.3.7	Hot Line.....	11
3.3.7	Phone Book.....	11
4	Web Configuration	12
4.1	Access the Built-in Web Server.....	12
4.2	Status.....	14
4.2.1	Phone Information	14
4.2.2	Network Information	15
4.3	Configurations.....	15
4.3.1	Preference	15
4.3.2	Network Configuration	18
4.3.3	Call Settings	20
4.3.3.1	H.323 Phone.....	20
4.3.3.2	SIP Phone	25
4.3.3.3	Media Settings.....	30
4.3.3.4	Dial Plan.....	32
4.3.4	Phone Settings.....	34
4.3.5	Save Changes.....	35
4.3.6	Discard Changes	36

4.4	Phone Book	36
4.5	Tools.....	36
4.5.1	Online Upgrade	37
4.5.2	Change Password	37
4.5.3	Reset Configuration.....	38
4.5.4	Reboot.....	38
4.6	Gain Settings	38

1 Introduction

1.1 Overview

The HT-882 is designed as a compact, high performance, and low cost Analog Terminal Adaptor (FXS Gateway). It comes with 8 FXS ports that enable traditional analog phone sets or PBX trunk lines to be used for VoIP communications. The HT-882 is a full featured FXS gateway and is designed for easy installation and configuration. It supports the two most widely used Open VoIP Standards (SIP and H.323). This allows the HT-882 to interoperate seamlessly with softswitches or IP PBXs made by various vendors. Its high performance offers toll quality voice, flexible networking, and feature-rich call functions. It is an ideal low cost solution for SME environment where multiple lines are required.

1.2 Protocols

- TCP/IP V4 (IP V6 auto adapt)
- ITU-T H.323 V4 Standard
- H.2250 V4 Standard
- H.245 V7 Standard
- H.235 Standard (MD5, HMAC-SHA1)
- ITU-T G.711 Alaw/ULaw, G.729A, G.729AB, and G.723.1 Voice Codec
- RFC1889 Real Time Data Transmission
- Proprietary Firewall-Pass-Through Technology
- SIP V2.0 Standard
- Simple Traversal of UDP over NAT (STUN)
- Web-base Management
- PPP over Ethernet (PPPoE)
- PPP Authentication Protocol (PAP)
- Internet Control Message Protocol (ICMP)
- TFTP Client
- Hyper Text Transfer Protocol (HTTP)
- Dynamic Host Configuration Protocol (DHCP)
- Domain Name System (DNS)
- User account authentication using MD5
- Out-band DTMF Relay: RFC 2833 and SIP Info

1.3 Hardware Specification

ARM9E Processor for high performance
DSP for voice codec and voice processing
Two 10/100M Based Ethernet ports for WAN/LAN connections.
LED status indicators
One FXS port
Ethernet Bridge

1.4 Software Specification

LINUX OS
Built-in HTTP for accessing internal parameters
PPPoE dial-up
Network Address Traversal (NAT) and Router functions
DHCP Client
DHCP Server
Firmware On-line upgrade
Phone Book
Memory Dial
Caller ID
Multiple Language Support
Billing Information for accounting purpose

1.5 List of the Package

- a) One HT-912 FXS Gateway
- b) One AC/DC Adapter (DC24V/300mA)
- c) One Ethernet cable (3-Meter long)

2 Installation

The device is designed for easy installation and can be installed in various network environments.

2.1 Appearance

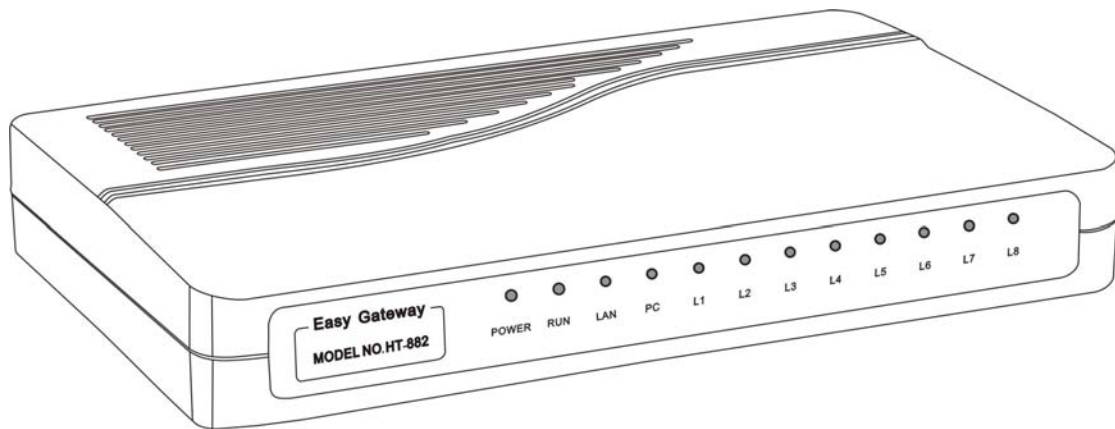

HT-882 Front View

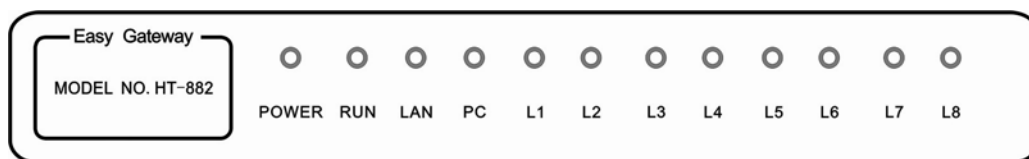

HT-882 Front Panel View

There are twelve LEDs on the front panel to display the current status of the HT-882.

1. **Power** – This LED lights up when the power is applied.
2. **RUN** – This LED flashes at a rate of 100ms ON and 100ms OFF when the device is booting up or connecting servers. It flashes at a rate of 1s ON and 1s OFF when server connection is established. It does not flash or turn on when the device fails.
3. **LAN** – This LED shows the LAN port status. It flashes when link and data activities occurs.
4. **PC** - This LED shows the PC port status. It flashes when link and data activities occurs.
5. **L1/L2/L3/L4/L5/L6/L7/L8** – These LEDs show the hook status of the corresponding FXS ports. Each LED lights up when the corresponding FXS line is OFF hook state (In Use).

The HT-882 has eight FXS port (Phone), two Ethernet ports (LAN and PC), Power Input, and a Reset inputs. They are all located at the back panel of the HT-882 as shown and described below.

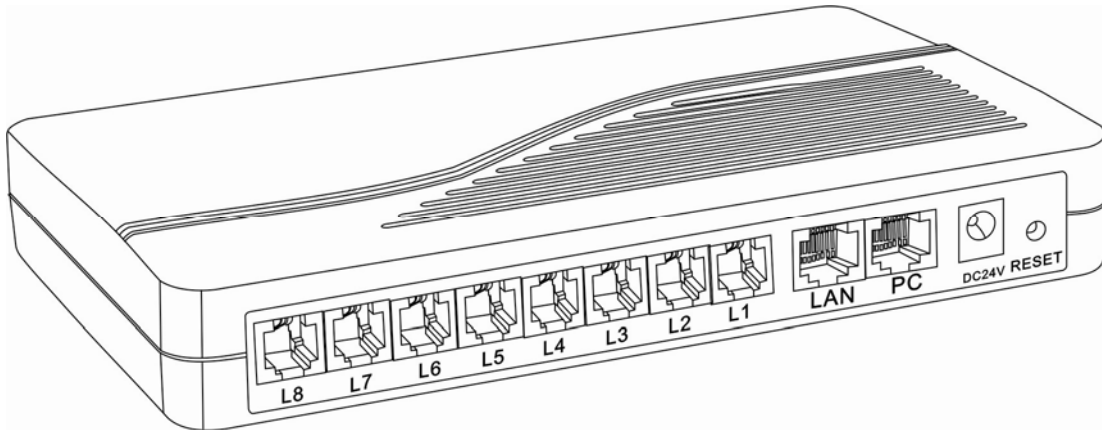

HT-882 Back View

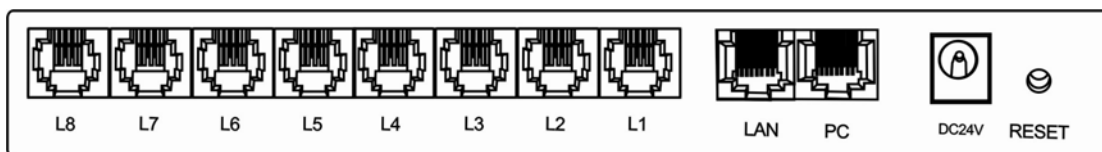

HT-882 Back Panel View

- 1) **L8/L7/L6/L5/L4/L3/L2/L1** – These ports are called FXS ports. They should be connected to traditional PSTN phones or PBX trunk lines via standard telephone cables. Please **DO NOT** connect these ports to CO Lines or PSTN PBX Extension Lines since this may cause damages to the device.
- 2) **LAN** – This port is to be connected to a network device for internet / network access.
- 3) **PC** – This port is to be connected to a PC/laptop or a network device.
- 4) **POWER DC24V/300mA** – The AC/DC Adapter provided is connected to this port.
- 5) **Reset** – The device is reset and rebooted when this push button switch is pressed.

2.2 Connection Diagram

The diagram below shows a typical installation of the device. Four traditional PSTN telephones are connected to the four FXS ports. The LAN port is connected to a XDSL/Cable Modem, router or gateway for connection to external network. The PC port is optional and it is intended to build a new local network segment (Fixed IP mode) or extend the existing network segment (Bridge mode). Once the wiring is done, the AC/DC Adapter should then be connected to power up the device.

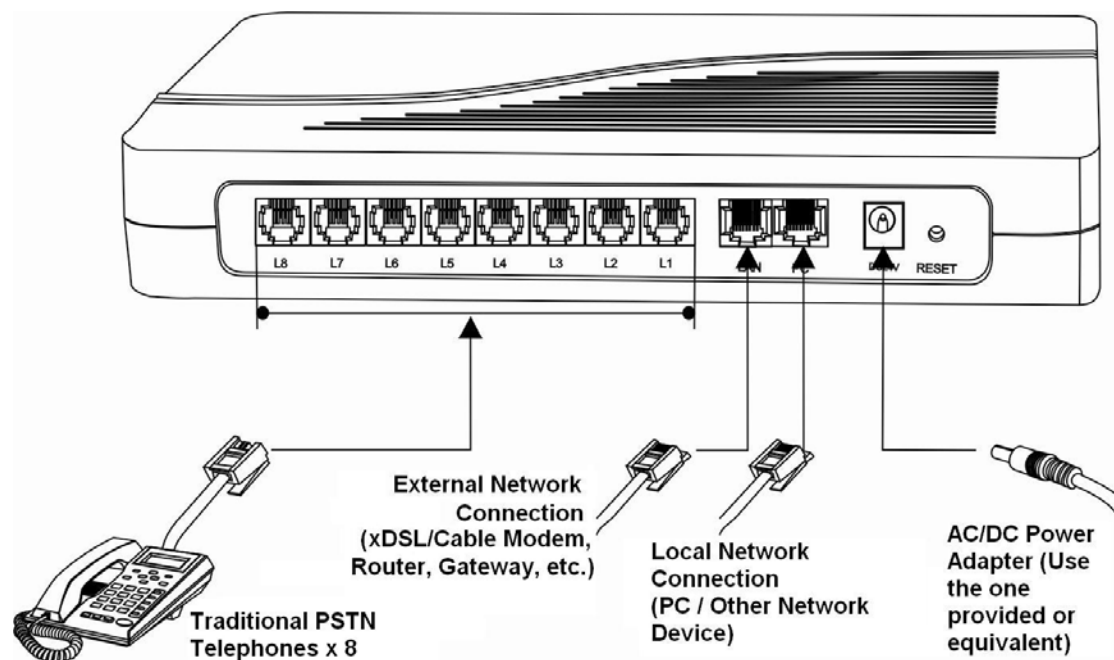

HT-882 Connection Diagram

3 Basic Operations

3.1 Star Commands

The star commands are used to access / control the device via the phone set connected to the Phone port. There are two sets of Star Commands and they are for:

1. Phone Configuration
2. Phone Operation

The first digit of a star command must be “*” and the rest must be digits from 0 to 9 and some commands require an operand. To perform a Star Command, dial the digit sequence on the phone set with DTMF dialing. The corresponding DTMF tones are generated and transmitted to the device.

Once the “*” code is dialed, a timeout is initiated to wait for additional valid input. If no input before the timeout expires, the “*” code is cancelled. The default timeout during is 5 seconds.

3.1.1 Star Commands for Phone Configuration

The available star commands for Phone Configuration are listed in the table below.

Star(*) Command	Function
*01	Generate a voice prompt on LAN Port IP assigned. It reports “Zero” if the LAN IP is not assigned.
*02	Generate a voice prompt on the PC Port IP assigned. It reports “Zero” if the PC IP Address is not assigned or bridge mode.
*03<Operand>#	Set LAN Port IP to <Operand>. <Operand> = xxx.xxx.xxx.xxx.
*04<Operand>#	Set PC Port IP to <Operand>. <Operand> = xxx.xxx.xxx.xxx.
*20	Send a remote support request.
*09987456#	Reset the IP Address for both LAN and PC ports. LAN Port IP = 192.168.0.1 (Factory default is DHCP mode)

	PC Port IP = 192.168.5.1 (Factory default is bridge mode.)
*11983185922#	Reset all system parameters back to factory defaults. Please see section 2.1 for hardware reset option.

Note: These commands are factory preset and cannot be modified.

3.1.2 Star Commands for Phone Operation

The available star commands for phone operation are 3-digit long at least and some contains operands. These Star Commands are shown in the table below and they can be programmed to other values via the built-in Web Server.

Star(*) Command	Function
*42	Hold the current call / Release the Hold call
*41	Call Transfer to another VoIP Number
*50	Phone book function key

3.2 Set up

The device supports two major configuration methods.

1. Provisioning Server

The device can be programmed at the factory, via a DHCP Host, or via the built-in web server to execute an Auto Provisioning Procedure to obtain a configuration file from a Provisioning Server (a HTTP or a TFTP server). This configuration file contains all the necessary parameters to set up the device for VoIP Services. This method requires no manual operation once the Auto Provision mode is set and greatly simplifies the installation and configuration of the device. This is a proprietary method. Please your local support for more information.

2. HTTP Web Server

The device comes with a built-in HTTP Web Server for user configuration. A PC on the same network segment can access the built-in Web Server by entering the IP address in a Web Browser. Please refer to Section 4 for more detailed information.

3.3 Phone Operation

The device supports VoIP calls once it is properly setup for VoIP service. Phone

calls are made via the phone set connected to the Phone port.

3.3.1 Make a Call

To make a VoIP call, place the phone set off hook to hear the dial tone. The dial tone is programmable in the **Preference** page of the built-in web server. Just dial a valid VoIP number and then “#” to make a call. If the “#” digit is omitted, the call will be dialed out when the Auto-dial Timeout expires. This timeout is programmable in **Preference page** and the default is 5 seconds. Please note that the phone set must be set to DTMF dialing mode.

3.3.2 Answer a Call

When an incoming call occurs, the phone set will ring at a ringing pattern defined in the **Phone Setting** page. Just place the phone set off hook to answer the call.

3.3.3 Answer a Call Waiting Call (not available in this model)

When an incoming call occurs during an active call, it is referred as a Call Waiting Call. The user hears an alerting (CAS) tone when a Call Waiting call occurs. This call waiting feature is only available in SIP; H.323 does not support this feature.

Press the FLASH key on phone keypad or flash the hook switch to answer a Call Waiting Call.

3.3.4 Hold a Call (For SIP only)

Dial the Star Command (the default is *42) to put the active call on hold. To release the call on hold:

- dial the Star Command again (the default is *42)
- place the phone off hook if it is already on hook
- place the phone on hook and then off hold if the phone is still off hook
- press the flash key if the phone is still off hook

This feature applies to VoIP SIP calls only.

3.3.5 Transfer a Call (For SIP only)

If two parties (A and B) are in an active call with each other. Part A can transfer the call to Party C by dialing the Star Command (the default is *41). The following two transfer modes are supported.

a) **Attended Transfer**

Party A dials *41 to hold the call with Party B and then dials the phone number to call Party C after hearing a dial tone. After Party C answers the call, Party A can then hang up to complete the transfer. Party B and Party C will then be connected.

b) **Unattended Transfer**

Party A dials the Star Command (the default is *41) to hold the call with Party B and then dials the phone number to call Party C after hearing a dial tone. Party A can then hang up the call when hearing a ring back tone. If Party C answers the call, Party C will then be connected with Party B. If Party C does not answer, Party A's phone will then ring after the call to Party C is terminated.

3.3.6 Call Forward (For SIP only)

The Call Forward feature allows a call to be forwarded to a designated number under the following conditions: Unconditional, Busy, No Answer, Busy or No Answer. This feature requires the support from the VoIP service provider and is enabled in the built-in web server.

3.3.7 Hot Line

The Hot Line feature sets the device to dial a preset VoIP number whenever the phone goes off hook. No other numbers can be dialed. This feature is enabled via the built-in web server.

3.3.7 Phone Book

The Phone Book feature offers 20 entries of names and phone numbers. Users can access the Phone Book via the built-in Web Server. There are two fields for each entry: Name and Number. The Name field is optional and used for reference to the number entered. The Number field is used for Phone Book Dialing and its value can be a number or a name. If this field is empty, the entry is considered as empty.

NO.	Name	Number
01	jonsoon	008612345678
02	lili	00178945621354
03	tony	008723245897
04		

The procedures to activate Phone Book dialing are:

1. Place the phone off hook
2. Wait for a dial tone
3. Dial the Star Command (the default is *50), the location (0 to 20), “#”
4. The Number in the Phone Book will be dialed out automatically.

4 Web Configuration

Other than Auto Provisioning, the device comes with a built-in Web Server (HTML) for the device configuration. In order to access this Web Server, the LAN or PC IP Address must be known. Star Commands are available to generate a voice prompt of the LAN or PC IP Address required and to assign IP Address to both LAN and PC ports. Please refer to Section 3.1.1 for more information.

4.1 Access the Built-in Web Server

The built-in Web Server can be accessed by typing the LAN / PC IP address in PC web browser. Please see below to determine which IP Address to be used to access the built-in Web Server.

Use LAN IP address when:

1. PC and the LAN port are connected and assigned to the same network segment. This condition applies to the PC that is connected to the PC port with bridge mode set.
2. LAN IP address is public and the PC has internet access.

Note: If a private IP is assigned to the LAN port, it may still be accessed from the internet provided that the local router is set up properly. Please consult your network administrator for more information.

Use PC IP address when:

1. PC and the PC port (HT-912) are connected and assigned to the same network segment.

To access the built-in Web Server, type the proper IP address (for example: 192.168.2.134 or <http://192.168.2.134> in a Web Browser as shown below (IE, Firefox, etc.).

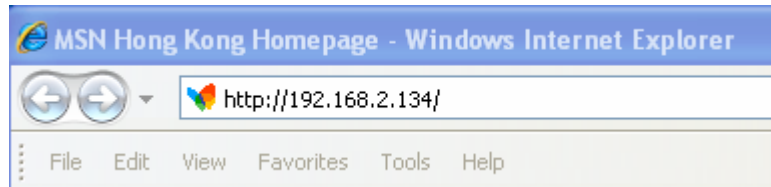

Once the device responds to the HTTP request, the Web Browser will prompt for a login window as shown below.



The device supports two login levels. For Administrator, please enter User name = "admin" and Password = "admin" (factory default). For User, please enter User name = "user" and the Password = "1234" (factory default). Both passwords can be changed in the Administrator mode. Only user password can be changed in the User mode. Please keep a record of the new passwords if changed. There is a Star Command to reset the passwords to the factory defaults.

The Administrator mode allows full access to the built-in Web Server whereas the User mode restricts the user from accessing the **Call Settings** page.

Once the login is successful, the Web Browser brings up the **Status** page as shown

below.



Phone Information		Network Information	
Serial Number		LAN Port	192.168.2.120
Firmware Version	A38HS-3.15-4	LAN MAC	
Hardware Model	8fxs	PC Port	In Bridge Mode
Line Register 1 Status	LOGOUT	PPPoE	Disabled
Line Register 2 Status	LOGOUT	Default Route	192.168.2.254
Line Register 3 Status	LOGOUT	DNS Server	202.96.128.68
Line Register 4 Status	LOGOUT		
Line Register 5 Status	LOGOUT		
Line Register 6 Status	LOGOUT		
Line Register 7 Status	LOGOUT		
Line Register 8 Status	LOGOUT		

4.2 Status

The Status page provides a brief summary of the Current Phone (Device) and Network information.

4.2.1 Phone Information

1 Serial Number

Each device is assigned with a unique serial number by the factory. This number is important for auto provision, technical support, and warranty repair. The product label at the bottom also contains this information.

2 Firmware Version

This field identifies the current Firmware Version installed.

3 Hardware Model

This field identifies the hardware model and version.

4 Phone Status

This field shows the status of server registration for each FXS port. If the device registers to the designated server(s) successfully, it displays the status "LOGIN". Otherwise, it displays "LOGOUT"

4.2.2 Network Information

1 LAN Port

This field shows IP address assigned to the LAN port.

2 PC Port

This field shows IP address assigned to the PC port.

3 PPPoE

This field shows the dial up status when PPPoE is enabled for ADSL login.

4 Default Route

The Default Route shows the IP address of the default gateway / router that is used in the current network environment.

5 DNS Server

This field shows the IP address of the DNS server to be used for domain name interpretation.

4.3 Configurations

To access the **Configurations** page, click on the “Configurations” tab on the left hand column. This brings up all the pages under this tab: **Preference**, **Network**, **Call Settings**, and **Phone Settings**.

4.3.1 Preference

This page configures the general settings in the device: **Language**, **Time Zone**, **Time server**, **Auto-Provision**, **Key(#) as Delimiter**, **Auto-dial Timeout**, **Network Tones**, **INFO Server**, **China Phone Code**.

Preference			
Language(语言)	<input type="text" value="简体中文"/>	Key(#) as Delimiter	<input checked="" type="radio"/> Enable <input type="radio"/> Disable
Time Zone	<input type="text" value="GMT+8"/>	Auto-dial Timeout	<input type="text" value="5"/>
Time Server	<input type="text" value="pool.ntp.org"/>	Network Tones	<input type="text" value="China"/>
Auto-provision	<input type="radio"/> Enable <input checked="" type="radio"/> Disable	INFO Server	<input type="text"/>
	RemoteControl>>	China Phone Code	<input type="radio"/> Enable <input checked="" type="radio"/> Disable

- 1 **Language** - This field sets the language to be used for initial access to the built-in Web Server. The languages currently available for selection are English, Simplified Chinese (简体中文), and Traditional Chinese (繁體中文). Once the language change is saved, it does not take effect until the device is rebooted.



To change the display language immediately, you can select the language icon as shown below. However, this does not change the default language.



- 2 **Time Zone** – This parameter specifies your local time zone in order for the date/time to be correctly displayed since the date/time obtained from a network time server is referenced to the Greenwich Mean Time (GMT). If your time zone is 8 hours ahead of the GMT, you need to enter the value “GMT+8” in this field.
- 3 **Time Server** – This parameter specifies the location of the network time server for obtaining the date and time information. It accepts both domain name and IP address.
- 4 **Auto Provision** – This parameter enables or disables the Auto Provision procedures. The **Auto Provision** is a batch script to obtain configuration and firmware upgrade information from a server. Once this option is enabled, two additional parameters (**Provision Server** and **Provision Interval**) are displayed. The **Provision Server** specifies the location of the designated provision server. The auto provision procedure is executed at boot up time and is repeated at a duration specified in the parameter **Provision Interval**.

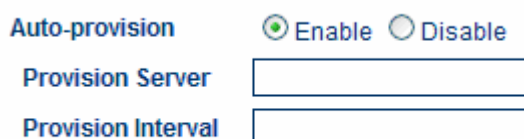

- 5 **Remote Control** – This feature is intended for remote technical support and it enables the device to connect to a remote server. Please contact your service provider for more information on this feature.
- 6 **Key(#) as Delimiter** – When dialing a VoIP number, the VoIP device needs to wait for the user to complete the number dialing before the call request is actually sent to the server. This parameter enables or disables the “#” key to be used to signal the number dialing is completed and the call request can be execute immediately.
- 7 **Auto-Dial Timeout** – This parameter sets the maximum delay for sending out a call request after the last number dialed. The range is 3 to 15 seconds and the

default is 5 seconds.

- 8 **Network Tones** – This parameter defines the network tones to be used. The predefined networks tones are: **China, Hong Kong, Taiwan, New Zealand, United Kingdom, United States, Korea, Slovenia, Czechoslovakia, India, Singapore, Israel, Malaysia, Indonesia, Thailand, Romania, Bangladesh, and Customized.** The **Customized** option allows user to define his own network tones. If the desired network tones selection is not available, user can use this **Customized** option.

Network Tones	<input type="text" value="Customized"/>
Dial Tone	<input type="text"/>
Ring Back Tone	<input type="text"/>
Busy Tone	<input type="text"/>
Indication Tone	<input type="text"/>

Each network tone contains 16 parameters as shown below.

1. number of cadences
2. repeat counter(0 - infinite, 1~n - repeat 1~n times)
3. cadence one on (in milliseconds)
4. cadence one off (in milliseconds)
5. cadence two on (in milliseconds)
6. cadence two off (in milliseconds)
7. cadence three on (in milliseconds)
8. cadence three off (in milliseconds)
9. tone #1 frequency, 300-3000(Hz)
10. tone #2 frequency, 300-3000(Hz)
11. tone #3 frequency, 300-3000(Hz)
12. tone #4 frequency, 300-3000(Hz)
13. tone #1 level, 0~31(0=3dB, -1dB per step)
14. tone #2 level, 0~31(0=3dB, -1dB per step)
15. tone #3 level, 0~31(0=3dB, -1dB per step)
16. tone #4 level, 0~31(0=3dB, -1dB per step)

Below are two sample network tone definitions for reference.

1. A New Zealand Dial Tone (400 Hz) is defined as **0,0,0,0,0,0,0,0,400,0,0,0,10,0,0,0.**
2. A New Zealand Busy tone (400Hz with a cadence of 500ms on and 500ms off (repeat)) is defined as **1,0,500,500,0,0,0,0,400,0,0,0,10,0,0,0.**

4.3.2 Network Configuration

This page configures the network interface for **LAN Port** and **PC Port**.

Network Configuration	
LAN Port	<input type="text" value="PPPoE"/> <input type="button" value="v"/>
802.1q VLAN	<input checked="" type="radio"/> Enable <input type="radio"/> Disable <input type="button" value="Advance>>"/>
PC Port	<input type="text" value="Static IP"/> <input type="button" value="v"/>
	<input type="button" value="Advance>>"/>

LAN Port – The LAN port is intended for internet access. It is normally connected to a network device (router or ADSL modem) which has internet access. The following 3 modes are available for selection.

Network Configuration	
LAN Port	<input type="text" value="PPPoE"/> <input type="button" value="v"/>
User name	<input type="text" value="DHCP"/>
Password	<input type="text" value="Static IP"/>
802.1q VLAN	<input checked="" type="radio"/> Enable <input type="radio"/> Disable
VLAN Id	<input type="text"/>
VLAN QoS	<input type="text"/>
	<input type="button" value="Advance<<"/>
Ethernet(MAC) Address	<input type="text"/>
IP Broadcast Address	<input type="text"/>

1. **DHCP** – This mode should be selected If the network device functions as a DHCP host, This allows the DEVICE to obtain all related network information / settings from the DHCP host.
2. **Static IP** – This mode sets the LAN port IP manually which can either be a public or private IP. Other network settings (Subnet Mask, Default Route, Primary DNS, Secondary DNS) should also be entered accordingly.

Network Configuration	
LAN Port	<input type="text" value="Static IP"/> <input type="button" value="v"/>
IP Address	<input type="text"/>
Subnet Mask(optional)	<input type="text"/>
Default Route	<input type="text"/>
Primary DNS	<input type="text"/>
Secondary DNS(optional)	<input type="text"/>

3. **PPPoE** – This selection is intended for broadband connection (ADSL / Cable modem) that requires dial up / authentication using PPPoE protocol. Both **User Name** and **Password** are required. Please consult your service provider for more information if needed. One advantage with the PPPoE dial up is that the IP address obtained for the LAN port is normally a public IP.

Network Configuration	
LAN Port	PPPoE
User name	<input type="text"/>
Password	<input type="text"/>

More advanced parameters for **802.1q VLAN** and **MAC** settings are available. Please consult your network administrator for assistance if needed.

PC PORT – The PC port is intended to provide an Ethernet connection to other network devices (for example: PC, network HUB.). Two modes of operation are available:

1. **Bridge mode** - This mode allows the network traffics at the PC port to be bypassed to LAN port. This means that the network device share the same network segment as the LAN port. There is no IP address assigned to the PC port.
2. **Fixed IP** - This mode sets the PC port **IP Addresss** (private IP) and **Subnet Mask** manually. This creates a new network segment for the network devices connected to the PC Port.

PC Port	Static IP
IP Address	<input type="text"/>
Subnet Mask	<input type="text"/>
DHCP Server	<input type="radio"/> Enable <input checked="" type="radio"/> Disable

To simplify network IP assignments, enable the DHCP Server for the PC Port. This allows network devices connected Port to obtain network IP and related information from the PC Port. Please consult your network administrator for proper settings of the DHCP Server

DHCP Server	<input checked="" type="radio"/> Enable <input type="radio"/> Disable
Starting Address	<input type="text"/>
Ending Address	<input type="text"/>
Static DNS(optional)	<input type="text"/>

4.3.3 Call Settings

This page configures all related settings for VoIP Service. Based on the two protocols (H.323 and SIP) supported, the operation of DEVICE is divided as two **Endpoint Types**: **H.323 Phone** and **SIP Phone**. Some of the parameters are unique to the **Endpoint Type** and are described separately below.

Call Settings	
Endpoint Type	H.323 Phone Advanced Settings>>
Endpoint Mode	Gatekeeper Mode Media Settings>>
Config Mode	Single Config
Phone Number	<input type="text"/>
Display Name	<input type="text"/>
H.323 ID	<input type="text"/>
Gatekeeper Address	<input type="text"/>
	<input type="checkbox"/> Enable VOS/AVS Encryption
	<input type="checkbox"/> Enable Authentication
Dial Plan	<input type="text"/>
	Fax Line>>

4.3.3.1 H.323 Phone

The **H.323 Phone** selection for **Endpoint Type** refers to the protocol used. The basic H.323 settings are:

1. **Endpoint Mode – Gatekeeper Mode** supports VoIP calling via a call server. Server Registration is required. **Direct Mode** supports making a VoIP call by dialing the IP addresses or an alias. Server Registration is not required.

Endpoint Type	H.323 Phone
Endpoint Mode	Direct Mode
	Direct Mode
	Gatekeeper Mode

2. **Config Mode** – The device supports two modes: **Single Config**, **Config by Line** and **Config by Group**.

Single Config allows only one phone number and Gatekeeper configuration.

Call Settings	
Endpoint Type	H.323 Phone
Endpoint Mode	Gatekeeper Mode
Config Mode	Single Config
Phone Number	
Display Name	
H.323 ID	
Gatekeeper Address	
	<input type="checkbox"/> Enable VOS/AVS Encryption
	<input type="checkbox"/> Enable Authentication
Dial Plan	
	Fax Line>>

Config by Line allows each FXS line to have its own configuration of the following parameters: phone number, H.323 ID, Gatekeeper Address, Encryption method, H.235 Auth., Dial Plan, and Fax Line.

Config Mode	Config by Line
	<input checked="" type="radio"/> Line 1 <input type="radio"/> Line 2 <input type="radio"/> Line 3 <input type="radio"/> Line 4 <input type="radio"/> Line 5 <input type="radio"/> Line 6 <input type="radio"/> Line 7 <input type="radio"/> Line 8
Phone Number	
H.323 ID	
Gatekeeper Address	
	<input type="checkbox"/> Enable VOS/AVS Encryption
	<input type="checkbox"/> H.235 Auth
Dial Plan	
	Fax Line>>

Config by Group allows up to 8 configuration groups. Each configuration group includes the following parameters: phone number, H.323 ID, Gatekeeper Address, Encryption method, H.235 Auth., Dial Plan, Activated Lines and Fax Line. The Line Parameter specifies which FXS lines are included in the group. Each FXS line can be assigned to each group.

Config Mode

Group 1 Group 2 Group 3 Group 4
 Group 5 Group 6 Group 7 Group 8

Phone Number

H.323 ID

Gatekeeper Address

Enable VOS/AVS Encryption
 H.235 Auth

Dial Plan

Activated Lines in Group 1
 L1 L2 L3 L4 L5 L6 L7 L8
 Fax Line>>

In order to activate the FXS line to be used, the following parameter must be checked for each group.

3. **Phone Number** - This parameter assigns the phone number used for registration in **Gatekeeper Mode**. This is used as an alias in **Direct Mode**.
4. **Display Name** – This parameter (optional) specifies the Caller name and is transmitted as part of the caller ID.
5. **H.323 ID** - This parameter is specified in the H.323 protocol. It is an identifier containing an alphanumeric string. Some gatekeepers may use this ID for authentication.
6. **Gatekeeper Address** - This assigns the location of the Gatekeeper for VoIP Service.
7. **VOS/AVS Encryption** – Both VOS2000 / AVS Encryption methods are used by major network equipment vendors in China to avoid VoIP blocking in order insure a reliable VoIP services. In order to use this, your VoIP service provider needs to support this encryption method. For H.323, VOS / AVS Encryption can be enabled or disabled for each number registration. VOS Encryption supports two modes: **Signaling Encryption** and **Signaling and Media Encryption**. Please consult your services provider for more information.
8. **Authentication** – If H.235 authentication is required, enable this field and enter the H.235 ID and Password.

H.235 Auth

H.235 ID

Password

9. **Fax** – Fax function is supported and can be enabled via this field. Fax can be transmitted via inband signal (**G.711**) or outband **T.38** commands. Please note

that there are many factors that can affect the fax transmission and it may not function properly or reliably

	Fax Line<<
Line1 Fax	<div style="border: 1px solid black; padding: 2px;"> <div style="border-bottom: 1px solid black; padding: 2px;">Disable</div> <div style="border-bottom: 1px solid black; padding: 2px;">Disable</div> <div style="border-bottom: 1px solid black; padding: 2px; background-color: #000080; color: white;">T.38</div> <div style="padding: 2px;">G.711</div> </div>

Advanced Settings

More settings are available under the **Advanced Settings** tab. These settings are common to all H.323 configurations. Depending on your network requirements, please consult your network administrator for the correct configuration.

	Advanced Settings<<
RAS Port	<input type="text"/>
Q.931 Port	<input type="text"/>
H.245 Port	<input type="text"/>
Fast Start	<input checked="" type="radio"/> Enable <input type="radio"/> Disable
Register Mode	Register Multiple Nur <input type="button" value="v"/>
DTMF Signaling	Outband <input type="button" value="v"/>
Signaling QoS	None <input type="button" value="v"/>
Signaling NAT Traversal	None <input type="button" value="v"/>
	Media Settings>>

1. **RAS Port** – This Port is used to convey the registration, admissions, bandwidth change, and status messages between two H.323 endpoints. If not specified, the port address is assigned automatically.
2. **Q.931 Port** – This port is used for call signaling to convey Call Setup and teardown messages between two H.323 endpoints. If not specified, the port address is assigned automatically.
3. **H.245 Port** – The H.245 requires at least 2 ports for media control protocol. It should be specified as a port range. If not specified, the port address is assigned automatically.
4. **Fast Start** - Fast Start is a new method of call setup that bypasses some usual steps in order to make it faster. In addition to the speed improvement, Fast Start allows the media channels to be operational before the CONNECT message is sent, which is a requirement for certain billing procedures. Leave this enabled if you are not sure.
5. **Register Mode** - Two registration modes are supported. **Register Multiple Numbers** mode means that multiple numbers are registered in a single

registration message. **Register Multiple Times** mode means that each number is registered in a separate registration message.

Register Mode

Register Multiple Nur
Register Multiple Numbe
Register Multiple Times

6. **DTMF Signaling** – This parameter sets the method of sending DTMF signals. **Inband** means that the DTMF signal is sent as an analog signal via the voice channel. **Outband** means that the DTMF signal is sent as DTMF command via the data channel and is commonly known as RFC2833. In **Outband** mode, a DTMF payload type is required and the default type is set to 101.

DTMF Signaling

Outband
Inband
Outband

7. **Signaling QoS** – This parameter sets the QoS mode for VoIP Signaling for better response time and more reliable VoIP Call signaling. Both IP TOS and Diffserv modes are supported. Please check with your network administrator or ISP for the correct setting.

Signaling QoS

None
None
IP TOS
DiffServ

8. **Signaling NAT Traversal** – NAT Traversal is an algorithm designed to solve a common problem in TCP/IP networking in establishing connections between hosts in private TCP/IP networks that use NAT devices. This parameter only sets the NAT Traversal mode for VoIP signaling. The 3 methods supported are **NAT Citron**, **Port-forward/DMZ**, and **Relay Proxy**.

Both **NAT Citron** and **Port-forward/DMZ** are well known NAT protocols are widely used; however, they require the support of local network.

Relay Proxy mode is a proprietary NAT protocol and it is designed for NAT Traversal with the capability of avoiding VoIP blockings. All VoIP signaling and/or media packets are encapsulated (encrypted as well if enabled) and transmitted via another port/channel to our proprietary Relay Server. Please contact your service provider to determine if this mode is supported.

Signaling NAT Traversal

None
None
Nat Citron
Port-forward/DMZ
Relay Proxy

RTP Port (range)

Relay Proxy mode is a proprietary NAT protocol and it requires the use of our Relay Proxy Server. All VoIP signaling packets are encapsulated (encrypted for more secured transmission if enabled) and transmitted via another port/channel. Up to 4 backup Relay Servers are supported. Once the designated Relay Server fails, the next available Relay Server on the back up list will be used. Once the designated Relay Server resumes operation, it will be used instead of the back up Relay Server.

Note: For Service providers, RELAY Proxy software is available at no charge. Please contact your supplier for support. For end user, please contact your service provider to see if this feature is available.

4.3.3.2 SIP Phone

The **SIP Phone** selection for **Endpoint Type** refers to the SIP protocol used. In SIP Phone mode, it supports two registration modes: **Single Server** and **Config by Line**.

Single Server mode - only one SIP registration is used for all 4 FXS lines. The HT-882 will perform line hunting automatically when a call is made or a call comes in.

Call Settings	
Endpoint Type	SIP Phone
Config Mode	Single Server Mode
Phone Number	<input type="text"/>
Phone Number 2	<input type="text"/>
Display Name	<input type="text"/>
SIP Proxy	<input type="text"/>
SIP Registrar Server	<input type="text"/>
Register Expiry(s)	60
Outbound Proxy	<input type="text"/>
Home Domain	<input type="text"/>
Authentication ID	<input type="text"/>
Password	<input type="text"/>
Dial Plan	<input type="text"/>
Call Forward Type	Not Forward
Call Forward Number	<input type="text"/>
Backup Server	<input type="radio"/> Enable <input checked="" type="radio"/> Disable
Fax Line>>	

In **Config by Line** mode, each FXS line has its own SIP registration and they are treated as independent lines. A Backup Server option is also available for each FXS line to

insure a more reliable SIP Service.

Call Settings	
Endpoint Type	SIP Phone
Config Mode	Config by Line
<input checked="" type="radio"/> Line 1 <input type="radio"/> Line 2 <input type="radio"/> Line 3 <input type="radio"/> Line 4 <input type="radio"/> Line 5 <input type="radio"/> Line 6 <input type="radio"/> Line 7 <input type="radio"/> Line 8	
Phone Number	<input type="text"/>
Phone Number 2	<input type="text"/>
Display Name	<input type="text"/>
SIP Proxy	<input type="text"/>
SIP Registrar Server	<input type="text"/>
Register Expiry(s)	300
Outbound Proxy	<input type="text"/>
Home Domain	<input type="text"/>
Authentication ID	<input type="text"/>
Password	<input type="text"/>
Dial Plan	<input type="text"/>
Call Forward Type	Not Forward
Call Forward Number	<input type="text"/>
Backup Server	<input type="radio"/> Enable <input checked="" type="radio"/> Disable
Fax Line>>	

The basic SIP settings are:

1. **Phone Number** – This parameter assigns the phone number used for SIP registration.
2. **Phone Number 2** – This parameter assigns the second phone number used for registration. This acts as a second phone number for SIP calls.
- 3.
4. **Display Name** – This parameter (optional) specifies the Caller name and is transmitted as part of the caller ID.
5. **SIP Proxy** – A SIP Proxy acts as a call manager of all incoming and outgoing calls. Specify the location (IP address / domain name) of the designated SIP Proxy used for SIP service. The standard port used is 5060. To specify a non-standard signaling port, add “:<port number>” to the of the location. For example: If SIP Proxy = yoursippbx.com, the signaling port is the standard port 5060. If SIP Proxy = yoursippbx.com:15060, the signaling port is 15060.
6. **SIP Registrar** – A SIP Registrar maintains a database of all SIP phones registered and their contact information. Specify the location (IP address / domain name) of the designated SIP Registrar. The standard port used is 5060. To specify a non-standard signaling port, add “:<port number>” to the of the location. For

example: If SIP Proxy = yoursippbx.com, the signaling port is the standard port 5060. If SIP Proxy = yoursippbx.com:15060, the signaling port is 15060.

7. **Registry Expiry(s)** – This specifies the expiry duration at the SIP Registrar after a successful registration. The range is 60 to 36400 seconds.
8. **Outbound Proxy** – A network node acts as proxy for outbound traffic between a client and a server. Please contact your network administration to determine if this proxy is available or not.
9. **Home Domain** – This field enables the use of home domain name as SIP registration instead of IP address.
10. **Authentication ID** – This field specifies the ID to be used for Authentication during a SIP registration.
11. **Password** – This field specifies the password used for Authentication during a SIP registration.
12. **Call Forward Type** – This defines the Call Forward condition and the available options are:
 - a) **Not Forward** – Call forward is disabled.
 - b) **Unconditional Forward** – Call is always forwarded.
 - c) **Busy Forward** – Call is forwarded when the line is in use / engaged.
 - d) **No Answer Forward** – Call is forwarded when it is not answered.
 - e) **Busy or No Answer Forward** – Call is forwarded when the line is in use or not answered.

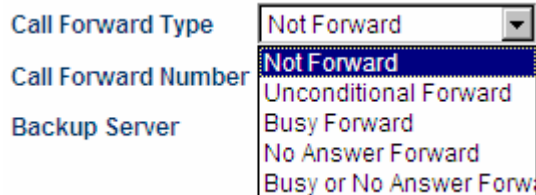

13. **Forward Number** – This defines the number to be used for Call Forward.
14. **Backup Server** – The backup option provides settings for a SIP backup server. Once the designated SIP Proxy and/ SIP Registrar fail, the backups will be used automatically.
15. **Fax** – Fax function is supported and can be enabled via this field. Fax can be transmitted via inband signal (**G.711**) or outband **T.38** commands. Please note that there are many factors that can affect the fax transmission and it may not function properly or reliably.

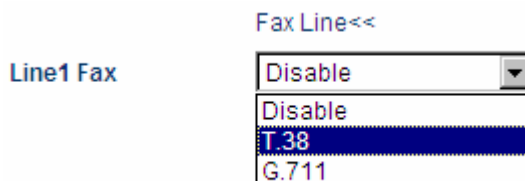

Advanced Settings

More settings are available under the **Advanced Settings** tab. Depending on your

network requirements, please consult your network administrator for the correct configuration.

Advanced Settings<<

Signaling Port

NAT Keep-alive Enable Disable

P2P Enable Disable

Virtual Ringback Enable Disable

Advanced Timing>>

DTMF Signaling

Outband DTMF type

RTP Payload Type

Signaling QoS

Signaling Encryption

Signaling NAT Traversal

1. **Signaling Port** – This Port is used to convey signaling message with the SIP Proxy. The standard port number is 5060.
2. **NAT Keep-alive** – When enabled, a dummy packet is sent to the local firewall / router in order to keep the ports opened for VoIP service.
3. **P2P** – This enables Peer-to-Peer calls.
4. **Virtual Ringback** – This enables a ringback tone to be generated whenever a call is made.
5. **DTMF Signaling** – This parameter sets the method of sending DTMF signals. **Inband** means that the DTMF signal is sent as an analog signal via the voice channel. **Outband** means that the DTMF signal is sent as DTMF command via the data channel. Both **RFC2833** and **SIP INFO** methods are supported. For **RFC2833**, a DTMF payload type is required and the default type is set to 101.

DTMF Signaling

Outband DTMF type

RTP Payload Type

6. **Signaling QoS** – This parameter sets the QoS mode for VoIP Signaling for better response time and more reliable VoIP Call signaling. Both IP TOS and DiffServ modes are supported. Please check with your network administrator or ISP for the correct setting.

Signaling QoS

None
IP TOS
DiffServ

7. **Signaling Encryption** – Five types of encryption methods are supported and these are used by various network equipment vendors in China to avoid blocking of SIP signaling traffics. Please consult your SIP service provided to determine which encryption method is supported.

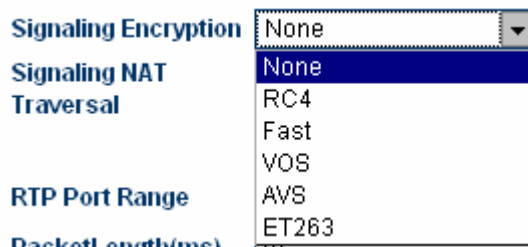

- a) **RC4** – RC4 Encryption Key is required when it is enabled.
 - b) **Fast** –
 - c) **VOS** – This encryption is developed by a network equipment vendor in Nanjing, China.
 - d) **AVS** – This encryption is developed by a network equipment vendor in Shanghai, China.
 - e) **ET263** – This encryption is supported by major network equipment vendors in China.
8. **Signaling NAT Traversal** – NAT Traversal is an algorithm designed to solve a common problem in TCP/IP networking in establishing connections between hosts in private TCP/IP networks that use NAT devices. This parameter only sets the NAT Traversal mode for VoIP signaling. The 2 methods supported are **STUN(RFC3489)** and **Relay Proxy**. A STUN Server is required for **STUN(RFC3489)**.

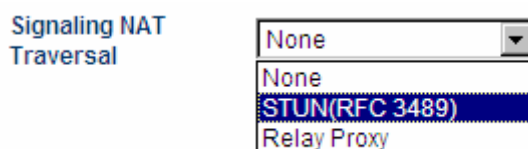

Relay Proxy mode is a proprietary NAT protocol and it requires the use of our Relay Proxy Server. All VoIP signaling packets are encapsulated (encrypted for more secured transmission if enabled) and transmitted via another port/channel. Up to 4 backup Relay Servers are supported. Once the designated Relay Server fails, the next available Relay Server on the back up list will be used. Once the designated Relay Server resumes operation, it will be used instead of the back up Relay Server.

Note: For Service providers, RELAY Proxy software is available at no charge. Please contact your supplier for support. For end user, please contact your service provider to see if this feature is available.

4.3.3.3 Media Settings

Once a VoIP call is established, the Media channel is used for voice transmission. The settings listed below configure the performance and operation of the Media channel.

Media Settings<<

RTP Port Range	<input type="text" value="16384"/> - <input type="text" value="32768"/>
PacketLength(ms)	<input type="text" value="20"/>
Jitter Buffer	<input type="text" value="Fixed"/> ▼
Delay(ms)	<input type="text" value="60"/>
Media QoS	<input type="text" value="None"/> ▼
Media Encryption	<input type="text" value="None"/> ▼
	<input checked="" type="checkbox"/> Symmetric RTP
Media NAT Traversal	<input type="text" value="None"/> ▼

1. **RTP Port (range)** – Audio stream is transmitted via Real Time Protocol (RTP) and at least 4 ports are used per voice channel. The default port range is 16384 – 32768. Specify the port range depending on your network environment if needed.
2. **Packet length (ms)** – This specify the length of a voice packet. The default packet length is 20 ms.
3. **Jitter Buffer Mode** –Three jitter modes are available. The **Fixed Mode**, which is the default mode, is a simple first in first out mode, with a fixed jitter buffer delay. By definition the jitter buffer depth is twice the jitter buffer delay. The **Sequential Mode** is also a fixed jitter buffer delay mode, but in this mode the jitter buffer function looks at the packet timestamp for dropped or out of sequence packet problems. The data packets are sorted based on the packet timestamp. The **Adaptive Mode** optimizes the size of the jitter buffer delay and depth in response to network conditions, in addition to the sequential mode.
4. **Media QoS** – QoS is also available for Media packets to improve voice quality. This is rather significant in a network environment with large amount of data traffics. Both **IP TOS** and **DiffServ** methods are supported.

Media QoS	<input type="text" value="None"/> ▼
	<input type="text" value="None"/>
	<input type="text" value="IP TOS"/>
	<input type="text" value="DiffServ"/>

5. **Media Encryption** – For secure voice transmission, RC4 / ET263 Encryption methods are supported for the media channel. Please make sure your service provider can support this encryption method before enabling this feature.

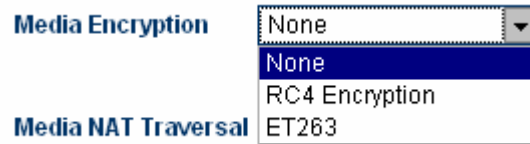

6. **Symmetric RTP** – Enable the media channel to use symmetric RTP ports. Some network environment demand the use of Symmetric RTP.
7. **Media NAT Traversal** – NAT Traversal can be set independently for Media packets. This gives a more flexible setting for various network environment. Three modes are supported: **STUN(RFC 3489)**, **Port-forward/DMZ**, and **Relay Proxy**.

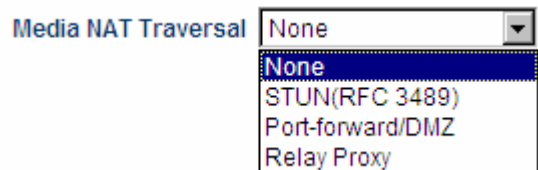

8. **Relay Proxy** mode is a proprietary NAT protocol and it requires the use of our Relay Proxy Server. All VoIP signaling packets are encapsulated (encrypted for more secured transmissions if enabled) and transmitted via another port/channel. Three relay modes of operation are supported.

Mode 1: Use UDP packets and encryption.

Mode 2: Use UDP packets and encryption; use single UDP port.

Mode 3: Use TCP packets and encryption; Use single TCP port;

The mode 2 and mode 3 are the passive and the port use is assigned by the RELAY SERVER.

Up to 4 backup Relay Servers are supported. Once the designated Relay Server fails, the next available Relay Server on the back up list will be used. Once the designated Relay Server resumes operation, it will be used instead of the back up Relay Server.

Media NAT Traversal	Relay Proxy
Address	<input type="text"/>
Port	<input type="text"/>
User Name	<input type="text"/>
Password	<input type="text"/>
	<input type="checkbox"/> Encryption
Relay Mode	1
Backup Relay Server 1	<input type="text"/>
Backup Relay Server 2	<input type="text"/>
Backup Relay Server 3	<input type="text"/>
Backup Relay Server 4	<input type="text"/>

Note: For Service providers, RELAY Proxy software is available at no charge. Please contact your supplier for support. For end user, please contact your service provider to see if this feature is available.

9. **Audio Codec Preference** – The table below list the voice codec priorities in descending order. Each voice codec can be enabled (place a check mark in the check box) or disabled individually. Select the voice code and then click on the UP or DOWN button to move the order on the list.

Audio Codec Preference<<

<input type="button" value="UP"/>	<input checked="" type="checkbox"/> alaw
<input type="button" value="DOWN"/>	<input checked="" type="checkbox"/> ulaw
	<input checked="" type="checkbox"/> g729
	<input checked="" type="checkbox"/> g729a
	<input checked="" type="checkbox"/> g729ab
	<input checked="" type="checkbox"/> g7231

4.3.3.4 Dial Plan

Dial Plan defines how the DEVICE processes a number when it is dialed. This field is located in the Calling Setting Window and it is available for both H.323 and SIP modes. The Dial Plan is very flexible and can be configured for a wide range of dialing applications.

Dial Plan

The basic syntax is “<event>:<action>|<event>:<action>|...”, where

<event> defines the event to be matched. A event consists of a sequence of digits. If a specific digit has a limited range, use the syntax [A-B] where A and B are both digit (0 to 9) and B is greater than A. The length of the input number can be limited by using "X" to represent each unknown digit. If this field is omitted, it means any event.

<action> defines the action to be taken on the number received and it consists of "-" (minus), "+" (plus), and digits. "-" followed by digits means to remove the digits from the beginning of the number entered. "+" followed by digits means to add the digits in front of the number entered. "|" means or and the order of priority is from left to right.

Note: For practical use, it should not be possible to reach the maximum length of the Dial Plan string.

Examples:

1. Dial Plan = "010:-010" means that the number dialed out will have the first 3 digits "010" removed when a number with the first digits as "010" is entered.
 - a) Number entered = "01082121234", actual number dialed = "82121234".
 - b) Number entered = "82121234", actual number dialed = "82121234".
2. Dial Plan = "1:+00" means that the number dialed out will have the "00" added in front of the number entered when a number with the first digit as "1" is entered,.
 - a) Number entered = "1082121234", actual number dialed = "00182121234".
 - b) Number entered = "82121234", actual number dialed = "82121234".
3. Dial Plan = "001:-001+1751" means that the number dialed out will the first 3 digits "001" changed to "1751" when a number with the first digits as "001" is entered.
 - a) Number entered = "00182121234", actual number dialed = "175282121234".
 - b) Number entered = "82121234", actual number dialed = "82121234".
4. Dial Plan = "XXXX:" means that the input number is limited to 4-digit long and will be dialed out immediately when the fourth digit is entered.
5. Dial Plan = "13XXXXXXXXX:+0" means that the input number is restricted to 11-digit long and the first two digits must be "13". When this condition is matched, the number dialed out will have a leading "0" added.
 - a) Number entered = "13901234567", actual number dialed = "013901234567".
 - b) Number entered = "12801234567", actual number dialed = "12801234567".
6. Dial Plan = "13[6-9]XXXXXXXXX:+0" means that the input number is restricted to 11-digit long and the first two digits must be "13" and the third digit can be 6, 7, 8, or 9. When this condition is matched, the number dialed out will have a leading "0" added.

- a) Number entered = "13901234567", actual number dialed = "013971234567".
- b) Number entered = "13001234567", actual number dialed = "13001234567".

Please note that the above samples are simple and intended to show the meaning of various rules. They may not have any practical meaning. A combination of these rules (joined with the symbol "|") can be realized for a much more complicated dialing application.

4.3.4 Phone Settings

The Phone Settings page configures the FXS port and its related operations. They are described in details below.

Phone Settings	
PhoneBook Function	<input type="text" value="*50"/>
FXS 48v Standby	<input type="radio"/> Enable <input checked="" type="radio"/> Disable
Billing Support	<input type="radio"/> Enable <input checked="" type="radio"/> Disable
	Ring Parameters>>
	Hot Line>>

- Star Commands** – Star Commands for **PhoneBook Function** (Default is ***50**) is programmable in this page. The format is ****+digits** and the number of digits is not limited. However, the detection is based on the first match. For example, if ****1** is defined, then the definition of ****1x..** is possible but will not be detected as a star command.
Star command for **Call Transfer** and **Call Hold** are preset by the factory and cannot be changed. Please refer to Section 3 for more information.
- FXS 48V Standby** – Normal FXS on hook line voltage is 24V. Enable this option to change the on hook line voltage to 48V.
- Billing Support** – Enable this option to enable call records to be sent to our Billing Server for billing purpose. Please contact your provider for more information on this.
- Ring Parameters** – The ringing frequency and cadence at the FXS port can be set here. It allows settings of 3 ringing cadences per ring cycle.

Ring Parameters<<	
Ring Frequency	<input type="text" value="25"/>
Ring Cadence One On	<input type="text" value="1200"/>
Ring Cadence One Off	<input type="text" value="4000"/>
Ring Cadence Two On	<input type="text"/>
Ring Cadence Two Off	<input type="text"/>

5. **Caller ID** – This defines the Caller ID signal to be sent from the FXS port. It supports both Bellcore/Telcordia and ETSI FSK Caller ID standards. The CID FSK Mode sets up the FSK modem to be used: Bellcore for Bell 202 and ETSI for V.23. Please refer to the Caller ID standard desired for further information.

CID FSK Mode	<input type="text" value="Bellcore"/>
	CID Signaling<<
1st Ring Duration	<input type="text" value="1000"/>
Delay Time Before CID	<input type="text" value="700"/>
Delay Time After CID	<input type="text" value="1000"/>

6. **Hot Line** – When this feature is enabled, the Hot Line Number defined will be dialed out automatically whenever the phone is off hook.

	Hot Line<<
Line1 Hot Line	<input checked="" type="radio"/> Enable <input type="radio"/> Disable
Hot Line Number	<input type="text"/>

4.3.5 Save Changes

When all changes have been made, click on the **Save Changes** tab to save all settings to the Flash memory.

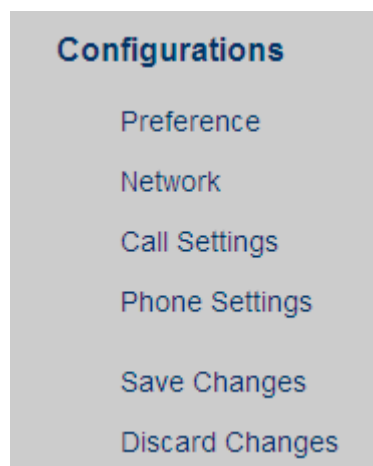

The message window below is displayed when the saving is completed.



4.3.6 Discard Changes

Click on the **Discard Changes** tab to ignore all changes made.

4.4 Phone Book

This page lists all the phone book entries for editing. Just click on **Save Changes** to save all entries to memory. The **Name** field is optional; only the **Number** field is used for memory dialing.

IP Phone Terminal

	NO.	Name	Number
Status	01	<input type="text"/>	<input type="text"/>
Configurations	02	<input type="text"/>	<input type="text"/>
Phone Book	03	<input type="text"/>	<input type="text"/>
Save Changes	04	<input type="text"/>	<input type="text"/>
Tools	05	<input type="text"/>	<input type="text"/>
	06	<input type="text"/>	<input type="text"/>
	07	<input type="text"/>	<input type="text"/>
	08	<input type="text"/>	<input type="text"/>
	09	<input type="text"/>	<input type="text"/>
	10	<input type="text"/>	<input type="text"/>

4.5 Tools

The **Tools** section is intended to offer the following functions: Online Upgrade, Change

Password, Reset Config, and Reboot.

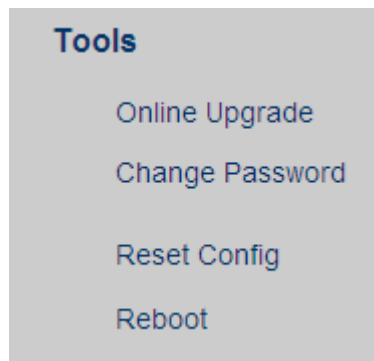

4.5.1 Online Upgrade

Click on the **Online Upgrade** tab to perform manual firmware upgrade. Enter the upgrade address as shown below. Please contact your service provider to determine if there is a new firmware available.

A screenshot of the 'Online Upgrade' web page. At the top, there is a dark blue header with the text 'Online Upgrade' in white. Below the header, the text 'Current Version: A38HS-3.15' is displayed. Underneath, there is a label 'Upgrade Site:' followed by a white text input field with a blue border. To the right of the input field is a grey button with the text 'Start' in white.

WARNING: Once the upgrade starts, a message window is display to show the upgrade status. DO NOT TURN OFF THE POWER WHILE THE FIRMWARE UPGRADE IS IN PROCESS!

4.5.2 Change Password

The device supports two login levels to the built-in webpage. The User level is intended for general user and is restricted from accessing the **Call Settings** page and **Reset Configuration** function. In this level, only the password for the user level can be changed. The default password for the user level (login ID = user) is "1234".

The Administrator level allows full accessing to the DEVICE configurations. In this level, the password for both levels can be change. The default password for the administrator level (login ID = admin) is "admin".

It is important to record the new password(s). If the admin password is lost, a special star command is available to reset all system settings. Please refer to section 3.1.1 for more information.

The image shows two sections for password management. The first section, titled "User Level", contains a "New Password:" text box, a "Confirm Password:" text box, and a "Change" button. The second section, titled "Administration Level", also contains a "New Password:" text box, a "Confirm Password:" text box, and a "Change" button.

4.5.3 Reset Configuration

This function can only be accessed in administrator login level. Click on the **Reset Configuration** tab to initiate the reset process. A message windows pops up to ask for confirmation. Click "Yes" to reset all configurations back factory defaults. Click "No" to cancel. Once the reset process is completed, the device reboots itself.

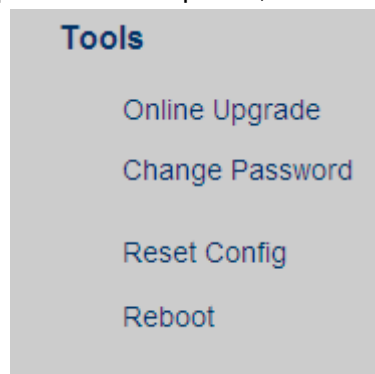

Please also see section 3.1.1 for a star command reset option.

4.5.4 Reboot

Click on the **Reboot** tab to reboot the device.

4.6 Gain Settings

This **Gain Settings** page is hidden and is only intended for users who is really interested in adjusting the receive level (Input Gain) and transmit level (Output Gain) of each FXS port.

The URL of this pge is http://xxx.xxx.xxx.xxx/en_US/gain.html. Enter this filed in a web browser and the **GAIN SETTINGS** page pops up. If you have not logged in to the

web server, you will need to login first.

The range of the gain setting is from -36 dB to +36 dB. Please adjust the gains with caution. If the input gain is too high, the DTMF dialing may not be detected properly. You can always click on **Reset** to resume to system default level.

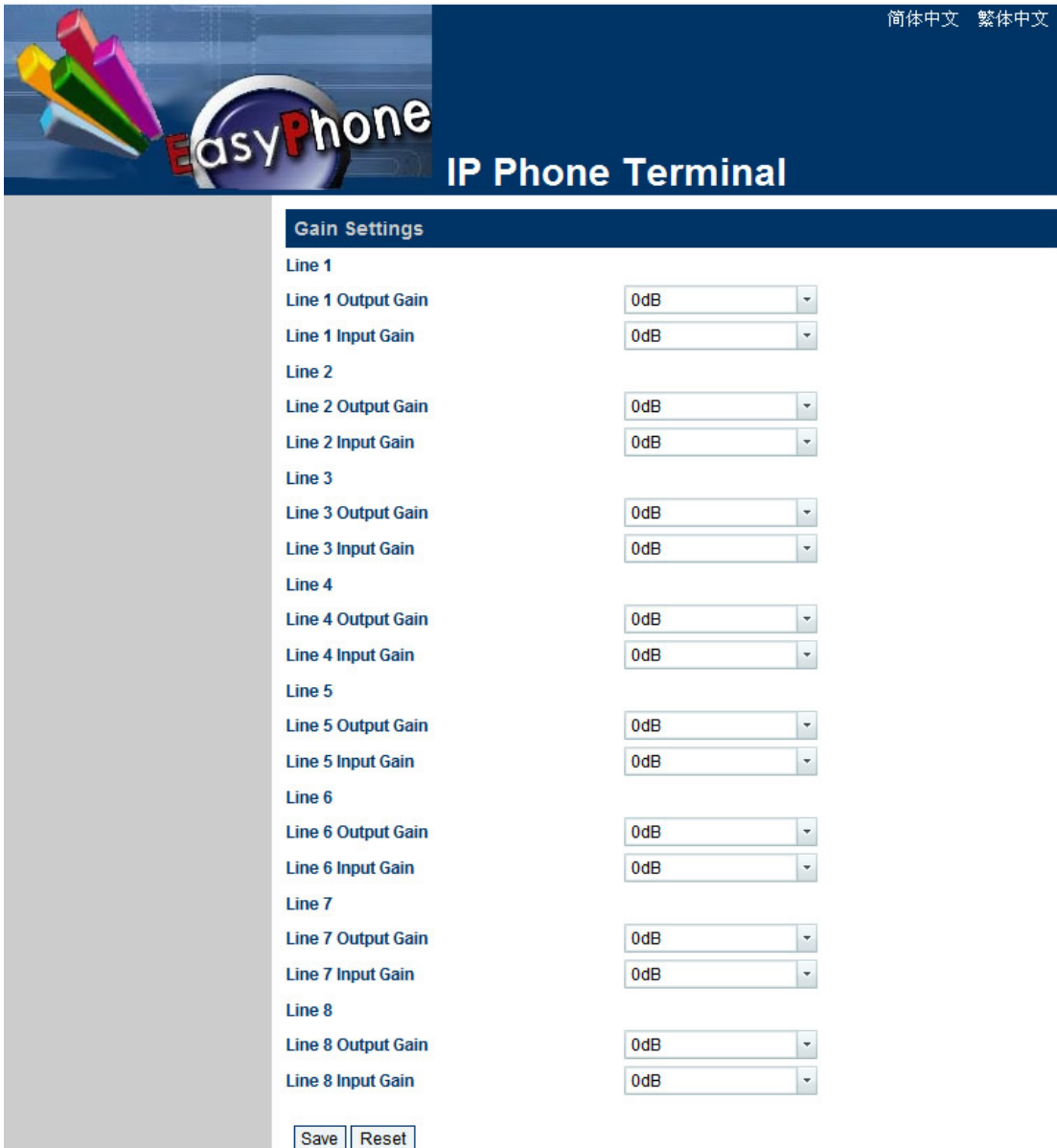

The screenshot displays the 'EasyPhone IP Phone Terminal' web interface. At the top left is the 'EasyPhone' logo with colorful 3D bars. At the top right are language options: '简体中文' and '繁体中文'. The main content area is titled 'Gain Settings' and lists configuration options for eight lines. Each line has two gain settings: 'Output Gain' and 'Input Gain', both currently set to '0dB'. At the bottom are 'Save' and 'Reset' buttons.

Line	Output Gain	Input Gain
Line 1	0dB	0dB
Line 2	0dB	0dB
Line 3	0dB	0dB
Line 4	0dB	0dB
Line 5	0dB	0dB
Line 6	0dB	0dB
Line 7	0dB	0dB
Line 8	0dB	0dB